

EURAX V 604

Programmable universal transmitter

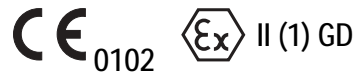

for DC currents or voltages, temperature sensors,
remote sensors or potentiometers



Application

The universal transmitter EURAX V 604 (Fig. 1) converts the input variable – a DC current or voltage, or a signal from a thermocouple, resistance thermometer, remote sensor or potentiometer – to a proportional analogue output signal.

The analogue output signal is either an impressed current or superimposed voltage which is processed by other devices for purposes of displaying, recording and/or regulating a constant.

A considerable number of measuring ranges including bipolar or spread ranges are available.

Input variable and measuring range are programmed with the aid of a PC and the corresponding software. Other parameters relating to specific input variable data, the analogue output signal, the transmission mode, the operating sense and the open-circuit sensor supervision can also be programmed.

The open-circuit sensor supervision is in operation when the EURAX V 604 is used in conjunction with a thermocouple, resistance thermometer, remote sensor or potentiometer.



Fig. 1. Transmitter EURAX V 604, front plate width 4 TE.

Features / Benefits

- **Input variable** (temperature, variation of resistance, DC signal) and **measuring range programmed using PC / Simplifies project planning and engineering** (the final measuring range can be determined during commissioning). **Short delivery times and low stocking levels**
- **Analogue output signal also programmed on the PC** (impressed current or superimposed voltage for all ranges between –20 and + 20 mA DC resp. –12 and + 15 V DC) / **Universally applicable. Short delivery times and low stocking levels**
- **Electrical insulation between measured variable, analogue output signal and power supply / Safe isolation acc. to IEC 1010**
- **Wide power supply tolerance / Only two operating voltage ranges between 20 and a maximum of 264 V DC/AC**
- **Available in type of protection “Intrinsic safety” [EEx ia] IIC** (see “Table 7: Data on explosion protection”)
- **Ex devices also directly programmable on site / No supplementary Ex interface needed**
- **Mechanical design of the transmitter: Plug-in module 4 TE (20.02 mm) for 19” rack-mounted case**
- **Other programmable parameters: specific measured variable data** (e.g. two, three or four-wire connection for resistance thermometers, “internal” or “external” cold junction compensation of thermocouples etc.), **transmission mode** (special linearised characteristic or characteristic determined by a mathematical relationship, e.g. output signal = f (measured variable)), **operating sense** (output signal directly or inversely proportional to the measured variable) and **open-circuit sensor supervision** (output signal assumes fixed preset value between –10 and 110%, supplementary output contact signalling relay) / **Highly flexible solutions for measurement problems**
- **All programming operations by IBM XT, AT or compatible PC running the self-explanatory, menu-controlled programming software, if necessary during operation / No ancillary hand-held terminals needed**
- **Digital measured variable data available at the programming interface / Simplifies commissioning, measured variable and signals can be viewed on PC in the field**
- **Standard software includes functional test program / No external simulator or signal injection necessary**
- **Self-monitoring function and continuously running test program / Automatic signalling of defects and device failure**

EURAX V 604

Programmable universal transmitter

Programming (Figs. 2 and 3)

A PC with RS 232 C interface (Windows 3.1x, 95, 98, NT or 2000), the programming cable PRKAB 600 and the configuration software VC 600 are required to program the transmitter. (Details of the programming cable and the software are to be found in the separate Data Sheet: PRKAB 600 Le.)

The connections between "PC ↔ PRKAB 600 ↔ EURAX V 604" can be seen from Fig. 2. The power supply must be applied to EURAX V 604 before it can be programmed.

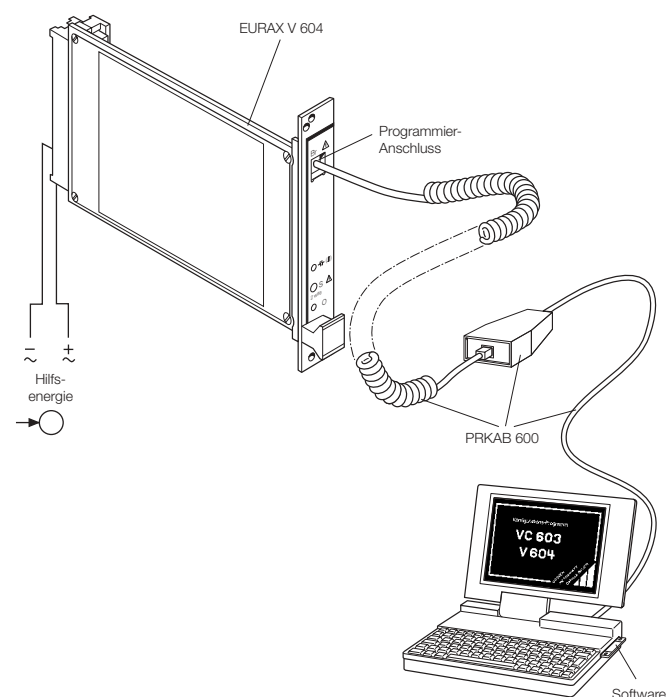

Fig. 2

The software VC 600 is supplied on a CD.

The programming cable PRKAB 600 adjusts the signal level and provides the electrical insulation between the PC and the transmitter EURAX V 604.

The programming cable PRKAB 600 is used for programming both standard and Ex versions.

Of the programmable details listed in section "Features/Benefits" **one** parameter – the **output signal** – has to be determined by PC programming as well as mechanical setting on the transmitter ...

... the **output signal range** by PC

... the **type** of output (current or voltage signal) has to be set by **DIP switch** (see Fig. 3).

The eight pole DIP switch is located on the PCB in the EURAX V 604.

DIP switches	Type of output signal
	impressed current
	superimposed voltage

Fig. 3

Technical Data

Measuring input

Measured variable M

The measured variable M and the measuring range can be programmed

Table 1: Measured variables and measuring ranges

Measured variables	Measuring ranges		
	Limits	Min. span	Max. span
DC voltages			
direct input	$\pm 300 \text{ mV}^1$	2 mV	300 mV
via potential divider ²	$\pm 40 \text{ V}^1$	300 mV	40 V
DC currents			
low current range	$\pm 12 \text{ mA}^1$	0.08 mA	12 mA
high current range	- 50 to + 100 mA ¹	0.75 mA	100 mA
Temperature monitored by two, three or four-wire resistance thermometers	- 200 to 850 °C		
low resistance range	0...740 Ω^1	8 Ω	740 Ω
high resistance range	0...5000 Ω^1	40 Ω	5000 Ω
Temperature monitored by thermocouple	- 270 to 1820 °C	2 mV	300 mV
Variation of resistance of remote sensors / potentiometers			
low resistance range	0...740 Ω^1	8 Ω	740 Ω
high resistance range	0...5000 Ω^1	40 Ω	5000 Ω

¹ Note permissible value of the ratio "full-scale value/span ≤ 20 ".

² Max. 30 V for Ex version with I.S. measuring input.

EURAX V 604



Programmable universal transmitter

DC voltage		Differential circuit:	2 identical three-wire resistance thermometers for deriving the mean temperature RT1–RT2, wiring diagram No. 7 ³
Measuring range limits:	See Table 1	Input resistance:	$R_i > 10 \text{ M}\Omega$
Direct input:	Wiring diagram No. 1 ¹	Lead resistance:	$\leq 30 \text{ }\Omega$ per lead
Input resistance:	$R_i > 10 \text{ M}\Omega$ Continuous overload max. $-1.5 \text{ V}, + 5 \text{ V}$	Thermocouples	
Input via potential divider:	Wiring diagram No. 2 ¹	Measuring range:	See Table 1 and 8
Input resistance:	$R_i = 1 \text{ M}\Omega$ Continuous overload max. $\pm 100 \text{ V}$	Thermocouple pairs:	Type B: Pt30Rh-Pt6Rh (IEC 584) Type E: NiCr-CuNi (IEC 584) Type J: Fe-CuNi (IEC 584) Type K: NiCr-Ni (IEC 584) Type L: Fe-CuNi (DIN 43710) Type N: NiCrSi-NiSi (IEC 584) Type R: Pt13Rh-Pt (IEC 584) Type S: Pt10Rh-Pt (IEC 584) Type T: Cu-CuNi (IEC 584) Type U: Cu-CuNi (DIN 43710) Type W5-W26 Re other thermocouple pairs on request
DC current		Standard circuit:	1 thermocouple, internal cold junction compensation, wiring diagram No. 8 ¹ 1 thermocouple, external cold junction compensation, wiring diagram No. 9 ¹
Measuring range:	See Table 1	Summation circuit:	2 or more thermocouples in a summation circuit for deriving the mean temperature, external cold junction compensation, wiring diagram No. 10 ¹
Low currents:	Wiring diagram No. 3 ¹	Differential circuit:	2 identical thermocouples in a differential circuit for deriving the mean temperature TC1–TC2, no provision for cold junction compensation, wiring diagram No. 11 ¹
Input resistance:	$R_i = 24.7 \text{ }\Omega$ Continuous overload max. 150 mA	Input resistance:	$R_i > 10 \text{ M}\Omega$
High currents:	Wiring diagram No. 3 ¹	Cold junction compensation:	
Input resistance:	$R_i = 24.7 \text{ }\Omega$ Continuous overload max. 150 mA	Internal:	Incorporated Ni 100
Resistance thermometer		Permissible variation of the internal cold junction compensation:	$\pm 0.5 \text{ K}$ at 23 °C, $\pm 0.5 \text{ K}/10 \text{ K}$
Measuring range limits:	See Table 1 and 8	External:	0...70 °C, programmable
Resistance types:	Type Pt 100 (DIN IEC 751) Type Ni 100 (DIN 43 760) Type Pt 20/20 °C Type Cu 10/25 °C Type Cu 20/25 °C See "Table 6: Specification and ordering information", Feature 6 for other Pt or Ni.		
Measuring current:	$\leq 0.38 \text{ mA}$ for measuring ranges 0...740 Ω or $\leq 0.06 \text{ mA}$ for measuring ranges 0...5000 Ω		
Standard circuit:	1 resistance thermometer: – two-wire connection, wiring diagram No. 4 ¹ – three-wire connection, wiring diagram No. 5 ¹ – four-wire connection, wiring diagram No. 6 ¹		
Summation circuit:	Series or parallel connection of 2 or more two, three or four-wire resistance thermometers for deriving the mean temperature or for matching other types of sensors, wiring diagram No. 4 – 6 ¹		

¹ See "Table 9: Measuring input".

EURAX V 604

Programmable universal transmitter

Resistance sensor, potentiometer		Short-circuit current:	≤ 40 mA
Measuring range:	See Table 1	Load capacity U_A :	20 mA
Resistance sensor types:	Type WF Type WF DIN Potentiometer see "Table 6: Specification and ordering information", Feature 5.	External resistance U_A :	$R_{\text{ext}} [\text{k}\Omega] \geq \frac{U_A [\text{V}]}{20 \text{ mA}}$
Measuring current:	≤ 0.38 mA for measuring range 0...740 Ω or ≤ 0.06 mA for measuring range 0...5000 Ω	Residual ripple:	< 1% p.p., DC ... 10 kHz < 1.5% p.p for an output span < 8 V
Kinds of input:	1 resistance sensor WF Current measured at pick-up, wiring diagram No. 12 ¹ 1 resistance sensor WF DIN Current measured at pick-up, wiring diagram No. 13 ¹ 1 resistance sensor for two, three or four-wire connection, wiring diagram No. 4–6 ¹ 2 identical three-wire resistance sensors for deriving a differential, wiring diagram No. 7 ¹	Fixed setting for the output signal A	
Input resistance:	$R_i > 10 \text{ M}\Omega$	After switching on:	A is at a fixed value for 5 s after switching on (default). Setting range –10 to 110% ² programmable, e.g. between 2.4 and 21.6 mA (for a scale of 4 to 20 mA). The green LED ON flashes for 5 s
Lead resistance:	≤ 30 Ω per lead	When input variable out of limits:	A is at either a lower or an upper fixed value when the input variable falls more than 10% below the minimum value of the permissible range ... exceeds the maximum value of the permissible range by more than 10%. Lower fixed value = –10% ² e.g. –2 mA (for a scale of 0 to 20 mA). Upper fixed value = 110% ² e.g. 22 mA (for a scale of 0 to 20 mA). The green LED ON flashes
Measuring output 		Open-circuit sensor:	A is at a fixed value when an open-circuit sensor is detected (see Section "Sensor and open-circuit lead supervision" ). The fixed value of A is configured to either maintain the value at the instant the open-circuit occurs or adopt a preset value between –10 and 110% ² , e.g. between 1.2 and 10.8 V (for a scale of 2 to 10 V). The green LED ON flashes and the red LED  lights continuously
Output signal A			
The output signal A can be configured for either an impressed DC current I_A or a superimposed DC voltage U_A by appropriately setting DIP switches. The desired range is programmed using a PC.			
Standard ranges for I_A :	0...20 mA or 4...20 mA		
Non-standard ranges:	Limits –22 to + 22 mA Min. span 5 mA Max. span 40 mA		
Open-circuit voltage:	Neg. –13,2...–18 V, pos. 16,5...21 V		
Burden voltage I_A :	+ 15 V, resp. –12 V		
External resistance I_A :	$R_{\text{ext max.}} [\text{k}\Omega] = \frac{15 \text{ V}}{I_{\text{AN}} [\text{mA}]}$ resp. = $\frac{-12 \text{ V}}{I_{\text{AN}} [\text{mA}]}$ I_{AN} = full-scale output current		
Residual ripple:	< 1% p.p., DC ... 10 kHz < 1.5% p.p. for an output span < 10 mA		
Standard ranges for U_A :	0...5, 1...5, 0...10 or 2...10 V		
Non-standard ranges:	Limits –12 to + 15 V Min. span 4 V Max. span 27 V		

¹ See "Table 9: Measuring input"

² In relation to analogue output span A.

EURAX V 604

Programmable universal transmitter

Output characteristic

Characteristic: Programmable

Table 2: Available characteristics (acc. to measured variable)

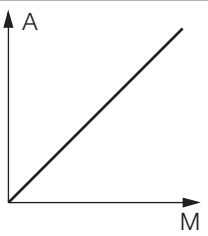
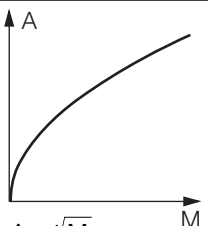
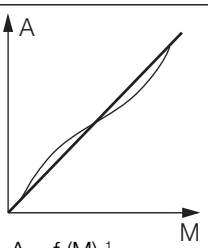
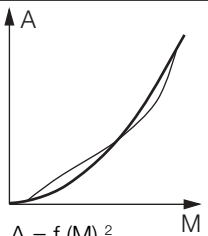
Measured variable	Characteristic	
DC voltage		
DC current		
Resistance thermometer (linear variation of resistance)		
Thermocouple (linear variation of voltage)		
Sensor or potentiometer	$A = M$	
DC voltage		
DC current		
DC voltage		
DC current		
Resistance thermometer (linear variation with temperature)		
Thermocouple signal (linear variation with temperature)		
Sensor or potentiometer	$A = f(M)^1$ linearised	
DC voltage		
DC current		
Sensor or potentiometer		
		Special characteristics

Operating sense: Programmable output signal directly or inversely proportional to measured variable

Setting time (IEC 770): Programmable from 2 to 30 s

Power supply H →○

DC, AC power pack (DC and 45...400 Hz)

Table 3: Rated voltages and permissible variations

Nominal voltage U_N	Permissible variation	Instrument version
24... 60 V DC / AC	DC -15...+ 33% AC ± 15%	Standard (Non-Ex)
85...230 V ³ DC / AC		
24... 60 V DC / AC	DC - 15...+ 33% AC ± 15%	Type of protection "Intrinsic safety" [EEx ia] IIC
85...230 V AC		
85...110 V DC	-15...+ 10%	

Power consumption: ≤1.6 W resp. ≤2.8 VA

Open-circuit sensor circuit supervision ↯

Resistance thermometers, thermocouples, remote sensors and potentiometer input circuits are supervised. The circuits of DC voltage and current inputs are not supervised.

Pick-up/reset level: 1 to 15 kΩ, acc. to kind of measurement and range

Signalling mode

Output signal A: Programmable fixed value. The fixed value of A is configured to either maintain the value at the instant the open-circuit occurs or adopt a preset value between -10 and 110%⁴, e.g. between 1.2 and 10.8 V (for a scale of 2 to 10 V)

Frontplate signals: The green LED ON flashes and the red LED ↯ lights continuously

Output contact K: **Relay** 1 potentially-free changeover contact (see Table 4)
Operating sense programmable
The relay can be either energized or de-energized in the case of a disturbance.
Set to "relay inactive" if not required!

² 25 input points M given referred to a linear output scale from -10% to + 110%. Pre-define output points: 0, 0, 0, 0.25, 1, 2.25, 4.00, 6.25, 9.00, 12.25, 16.00, 20.25, 25.00, 30.25, 36.00, 42.25, 49.00, 56.25, 64.00, 72.25, 81.00, 90.25, 100.0, 110.0, 110.0%.

¹ 25 input points M given referred to a linear output scale from -10% to + 110% in steps of 5%.

³ An external supply fuse must be provided for DC supply voltages >125 V.

⁴ In relation to analogue output span A.

EURAX V 604

Programmable universal transmitter

Supervising a limit GW (II)

This Section only applies to transmitters which are **not** configured to use the output contact K in conjunction with the open-circuit sensor supervision (see Section "Open-circuit sensor circuit supervision →").

This applies ...

... in all cases when the measured variable is a DC voltage or current

... when the measured variable is a resistance thermometer, a thermocouple, a remote sensor or a potentiometer and the relay is set to "Relay disabled"

Limit type: Programmable

- Disabled
- Lower limit value of the measured variable (see Fig. 4, left)
- Upper limit value of the measured variable (see Fig. 4, left)
- Maximum rate of change of the measured variable

Slope = $\frac{\Delta \text{ measured variable}}{\Delta t}$

(see Fig. 4, right)

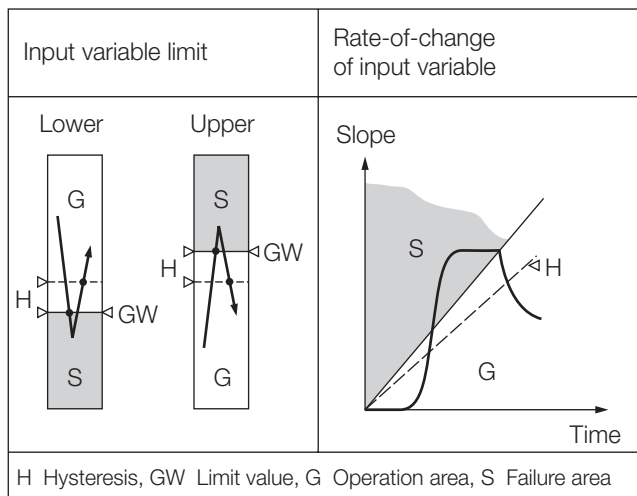

Fig. 4. Switching function according to limit monitored.

Trip point setting using PC for GW: Programmable

- between -10 and 110%¹ (of the measured variable)
- between ± 1 and ± 50%¹/s (of the rate-of-change of the measured variable)

Reset ratio: Programmable

- between 0.5 and 100%¹ (of the measured variable)
- between 1 and 100%¹/s (of the rate-of-change of the measured variable)

Operating and resetting delays: Programmable

- between 1 to 60 s

Operating sense: Programmable

- Relay energized, LED on
- Relay energized, LED off
- Relay de-energized, LED on
- Relay de-energized, LED off (once limit reached)

Relay status signal: GW by red LED (II)

Table 4: Contact arrangement and data

Symbol	Material	Contact rating
	Gold flashed silver alloy	AC: ≤ 0.5 A/125 V (62.5 VA) DC: ≤ 1 A/0.01...30 V (30 W)

Relay approved by UL, CSA

Programming connector

Interface: RS 232 C

FCC-68 socket: 6/6 pin

Signal level: TTL (0/5 V)

Power consumption: Approx. 50 mW

Accuracy data (acc. to DIN/IEC 770)

Basic accuracy: Max. error ≤ ± 0.2%
Including linearity and repeatability errors for current, voltage and resistance measurement

Additional error (additive):

- < ± 0.3% for linearised characteristic
- < ± 0.3% for measuring ranges < 5 mV, 0.3...0.75 V, < 0.2 mA or < 20 Ω
- < ± 0.3% for a high ratio between full-scale value and measuring range > factor 10, e.g. Pt 100 175.84 Ω...194.07 Ω ≥ 200 °C...250 °C
- < ± 0.3% for current output < 10 mA span
- < ± 0.3% for voltage output < 8 V span
- < 2 · (basic and additional error) for two-wire resistance measurement

Reference conditions:

Ambient temperature: 23 °C, ± 2 K

Power supply: 24 V DC ± 10% and 230 V AC ± 10%

Output burden: Current: 0.5 · R_{ext} max.
Voltage: 2 · R_{ext} min.

¹ In relation to analogue output span A.

EURAX V 604

Programmable universal transmitter

Influencing factors:

Temperature	< ± 0.1 ... 0.15% per 10 K
Burden	< ± 0.1% for current output < 0.2% for voltage output, providing $R_{ext} > 2 \cdot R_{ext, min}$.
Longtime drift	< ± 0.3% / 12 months
Switch-on drift	< ± 0.5%
Common and transverse mode influence	< ± 0.2%
+ or – output connected to ground:	< ± 0.2%

Installation data

Housing:	Plug-in Europe format module 100x160 mm (see Section “Dimensional diagram”)
Space:	Frontplate width 4 TE (20.02 mm)
Frontplate colour:	Grey RAL 7032
Designation:	EURAX V 604
Mounting position:	Any
Electrical connections:	48-pin connector, DIN 41612, pattern F Contact layout see Section “Electrical connections”
Coding:	By coding pins, extant or broken out, see Section “Electrical connections”
Weight:	Approx. 0.2 kg

Electrical insulation:

All circuits (measuring input/measuring output/power supply/output contacts) are electrically insulated.

Programming connector and measuring input are connected.

The PC is electrically insulated by the programming cable PRKAB 600.

Standards

Electrical standards:	Acc. to IEC 1010 resp. EN 61 010
Electromagnetic compatibility:	The standards DIN 50 081-2 and DIN EN 50 082-2 are observed
Intrinsically safe:	Acc. to DIN EN 50 020: 1996-04
Protection class:	IP 00 acc. to EN 60 529
Operating voltages:	Measuring input < 40 V Programming connector, measuring output < 25 V Output contacts, power supply < 250 V

Rated insulation voltage:

Measuring input, programming connector, measuring output, output contacts, power supply < 250 V

Pollution degree:

2

Installation category II:

Measuring input, programming connector, measuring output, output contacts

Installation category III:

Power supply

Protection against electric shock:

Acc. to IEC 1010 and DIN/VDE 106 Part 101

Test voltage:

Measuring input and programming connector to:

– output signal 2.3 kV,
50 Hz, 1 min.

– power supply 3.7 kV,
50 Hz, 1 min.

– output contact 2.3 kV,
50 Hz, 1 min.

Measuring output to:

– power supply 3.7 kV,
50 Hz, 1 min.

– output contact 1 kV,
50 Hz, 1 min.

Serial interface for the PC to:

– everything else 4 kV, 50 Hz, 1 min.
(PRKAB 600)

Ambient conditions

Commissioning temperature:

–10 to + 55 °C

Operating temperature:

–25 to + 55 °C, Ex –20 to + 55 °C

Storage temperature:

–40 to + 70 °C

Relative humidity, annual mean:

≤ 75% standard climatic rating
≤ 95% enhanced climatic rating

Basic configuration

The transmitter EURAX V 604 is also available already programmed with a **basic** configuration which is especially recommended in cases where the programming data is not known at the time of ordering (see “Table 6: Specification and ordering information”, Feature 4.).

Basic configuration:

Measuring input 0...5 V DC
Measuring output 0...20 mA linear,
fixed value 0%
during 5 s after switching on
Setting time 0.7 s
Open-circuit supervision inactive
Mains ripple suppression 50 Hz
Limit functions inactive

Position of jumpers



EURAX V 604

Programmable universal transmitter

Tableau 5: Standard versions

The following 4 transmitter versions are already programmed for **basic** configuration and are available ex stock. It is only necessary to quote the **Order No.**:

Instruments in standard (non-Ex) version (measuring circuit non intrinsically safe)

Cold junction compensation	Climatic rating	Power supply	Order Code	Order No.
without	standard	24... 60 V DC / AC	604-2110	997 588
		85...230 V DC / AC	604-2210	997 603

Instruments in [EEx ia] IIC version (measuring circuit intrinsically safe)

Cold junction compensation	Climatic rating	Power supply	Order Code	Order No.
without	standard	24...60 V DC / AC	604-2310	997 629
		85...110 V DC / 85...230 V AC	604-2410	997 645

The complete Order Code 604-..., according to "Table 6: Specification and ordering information" must be stated for versions other than the basic version and for special configurations.

The same applies to orders for the preferred series of devices that Camille Bauer are required to supply in 19" equipment racks, i.e. the complete Order Code 604-..., according to "Table 6: Specification and ordering information" must be stated in the order. (This is necessary because the stores numbers are needed for special instruments).

Where one is required, order the reference point compensation resistor Ni 100 as a separate item (see price list V 604-2 V Pe)

Basic configuration see Section "Technical data".

Other accessories and spares see price list V 604-2 V Pe.

Table 6: Specification and ordering information

Order Code 604 -														
Features, Selection	*SCODE	no-go	2	1
1. Mechanical design 2) Plug-in module for 19" case														
2. Version / Power supply H (nominal voltage U_N)														
1) Standard / 24... 60 V DC/AC														
2) Standard / 85...230 V DC/AC														
3) [EEx ia] IIC / 24... 60 V DC/AC														
4) [EEx ia] IIC / 85...110 V DC														
85...230 V AC														

EURAX V 604

Programmable universal transmitter

Order Code 604 -							
Features, Selection	*SCODE	no-go					
3. Climatic rating / Cold junction compensation							
1) Standard climatic rating; instrument without cold junction compensation	G		1
3) Extra climatic rating; instrument without cold junction compensation	G		3
5) Standard climatic rating; instrument with cold junction compensation, provision for fitting compensating resistor supplied on assembly BT 901, BT 901 is not supplied			5
6) Extra climatic rating; instrument with cold junction compensation, provision for fitting compensating resistor supplied on assembly BT 901, BT 901 is not supplied			6
7) Standard climatic rating; instrument with cold junction compensation, provision for fitting compensating resistor supplied on assembly BT 901-.. (G84), BT 901-.. (G84) is not supplied			7
8) Extra climatic rating; instrument with cold junction compensation, provision for fitting compensating resistor supplied on assembly BT 901-.. (G84), BT 901-.. (G84) is not supplied			8
A) Standard climatic rating; instrument with cold junction compensation, compensating resistor fitted on assembly BT 901, BT 901 also supplied already wired			A
B) Extra climatic rating; instrument with cold junction compensation, compensating resistor fitted on assembly BT 901, BT 901 also supplied already wired			B
C) Standard climatic rating; instrument with cold junction compensation, compensating resistor fitted on assembly BT 901-.. (G84), BT 901-.. (G84) also supplied already wired			C
D) Extra climatic rating; instrument with cold junction compensation, compensating resistor fitted on assembly BT 901-.. (G84), BT 901-.. (G84) also supplied already wired			D
4. Configuration							
0) Basic configuration, programmed	Z		.	0	.	.	.
1) Programmed to order			.	1	.	.	.
2) Programmed to order with test certificate			.	2	.	.	.
Line 0: If you wish to order the basic configuration, the line "0)" must be selected for options 4 to 13, i.e. all the digits of the order code after the 4th. are zeros							
Lines 0 and 1: No test certificate							
5. Measured variable / Measuring input M							
DC voltage							
0) 0... 5 V linear	C		.	.	0	.	.
1) 1... 5 V linear	C	Z	.	.	1	.	.
2) 0...10 V linear	C	Z	.	.	2	.	.
3) 2...10 V linear	C	Z	.	.	3	.	.
4) Linear input, other ranges [V]	C	Z	.	.	4	.	.
5) Square root input function [V]	C	Z	.	.	5	.	.
6) Input x 3/2 [V]	C	Z	.	.	6	.	.
Lines 4 to 6: DC [V] 0...0.002 to 0...≤ 40 V (Ex max. 30 V) or span 0.002 to 40 V between -40 and 40 V, ratio full-scale/span ≤ 20							

Feature "5. Measured variable / Measuring input M" continued on next page!

EURAX V 604

Programmable universal transmitter

Order Code 604 -			*SCODE	no-go	
Features, Selection					Insert code in the 1st box on the next page!
5. Measured variable / Measuring input M (continuation)					
DC current					
7) 0...20 mA linear			C	Z	7
8) 4...20 mA linear			C	Z	8
9) Linear input, other ranges [mA]			C	Z	9
A) Square root input function [mA]			C	Z	A
B) Input x 3/2 [mA]			C	Z	B
Lines 9, A and B: DC [mA] 0...0.08 to 0...100 mA or span 0.08 to 100 mA between -50 and 100 mA, ratio full-scale/span ≤ 20					
Resistance thermometer, linearised					
C) Two-wire connection, R_L [Ω]			E	Z	C
D) Three-wire connection, $R_L \leq 30 \Omega/\text{wire}$			E	Z	D
E) Four-wire connection, $R_L \leq 30 \Omega/\text{wire}$			E	Z	E
Resistance thermometer, non-linearised					
F) Two-wire connection, R_L [Ω]			E	Z	F
G) Three-wire connection, $R_L \leq 30 \Omega/\text{wire}$			E	Z	G
H) Four-wire connection, $R_L \leq 30 \Omega/\text{wire}$			E	Z	H
J) Temperature difference [deg] 2 identical resistance thermometers in three-wire connection			E	Z	J
Lines C and F: Specify total lead resistance R_L [Ω], any value between 0 and 60 Ω. This may be omitted, because two leads can be compensated automatically on site. Line J: Temperature difference; specify measuring range [deg], also for Feature 6.: t_{\min} ; t_{\max} ; $t_{\text{reference}}$					
Thermocouple linearised					
K) Internal cold junction compensation (not for type B)			DT	GZ	K
L) External cold junction compensation (specify 0° for type B)* tK [°C]			D	Z	L
Thermocouple not linearised					
M) Internal cold junction compensation (not for type B)			DT	GZ	M
N) External cold junction compensation (specify 0° for type B)* tK [°C]			D	Z	N
P) Average temperature [n] tK [°C]			D	Z	P
Q) Temperature difference [deg] 2 identical thermocouples			D	Z	Q
Lines L, N and P: Specify external cold junction temperature t_K [°C], any value between 0 and 70 °C Line P: State number of sensors [n] Line Q: Temperature difference; specify measuring range [deg], also for Feature 6.: t_{\min} ; t_{\max} ; $t_{\text{reference}}$					

* Because of its characteristic, thermocouple type B does not require compensating leads nor cold junction compensation.

Feature "5. Measured variable / Measuring input M" continued on next page!

EURAX V 604

Programmable universal transmitter

Order Code 604 -			
Features, Selection		*SCODE	no-go
6. Sensor type / Temperature range (continuation)			
B) Type B: Pt30Rh-Pt6Rh	[°C]		CEFTZ
E) Type E: NiCr-CuNi	[°C]		CEFZ
J) Type J: Fe-CuNi	[°C]		CEFZ
K) Type K: NiCr-Ni	[°C]		CEFZ
L) Type L: Fe-CuNi	[°C]		CEFZ
N) Type N: NiCrSi-NiSi	[°C]		CEFZ
R) Type R: Pt13Rh-Pt	[°C]		CEFZ
S) Type S: Pt10Rh-Pt	[°C]		CEFZ
T) Type T: Cu-CuNi	[°C]		CEFZ
U) Type U: Cu-CuNi	[°C]		CEFZ
W) Type W5-W26Re	[°C]		CEFZ
Lines B to W: Specify measuring range in [°C] or °F, refer to Table 8 for the operating limits for each type of sensor. For temperature difference measurement: specify measuring range and reference temperature for 2nd sensor (t_{min} ; t_{max} ; reference) e.g. 100; 250; 150			
7. Output signal / Measuring output A			
0) 0...20 mA, $R_{ext} \leq 750 \Omega$. 0
1) 4...20 mA, $R_{ext} \leq 750 \Omega$		Z	. 1
2) Non-standard	[mA]	Z	. 2
3) 0... 5 V, $R_{ext} \geq 250 \Omega$		Z	. 3
4) 1... 5 V, $R_{ext} \geq 250 \Omega$		Z	. 4
5) 0...10 V, $R_{ext} \geq 500 \Omega$		Z	. 5
6) 2...10 V, $R_{ext} \geq 500 \Omega$		Z	. 6
7) Non-standard	[V]	Z	. 7
Line 2: -22 to + 22, span 5 to 40 mA Line 7: -12 to + 15, span 4 to 27 V			
8. Output characteristic			
0) Directly proportional, initial start-up value 0%			. . 0
1) Inversely proportional, initial start-up value 100%		Z	. . 1
2) Directly proportional, initial start-up value	[%]	Z	. . 2
3) Inversely proportional, initial start-up value	[%]	Z	. . 3
9. Output time response			
0) Rated settling time approx. 1 s			. . . 0
1) Others	[s]	Z	. . . 1
Line 1: Any whole number from 2 to 30 s			

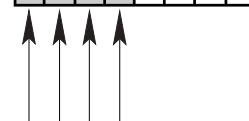

B
 E
 J
 K
 L
 N
 R
 S
 T
 U
 W

EURAX V 604

Programmable universal transmitter

Order Code 604 -															
Features, Selection										*SCODE	no-go	↑ ↑ ↑ ↑			
10. Open-circuit sensor signalling															
Without / open-circuit sensor signal / relay / output signal A corresponding to input variable [%]															
0) No sensor signal (for current or voltage measurement)											DEF	0			
1) With sensor signal / relay disabled / output signal A											CZ	1			
2) With sensor signal / relay energized / output signal A										K	CZ	2			
3) With sensor signal / relay de-energized / output signal A										K	CZ	3			
4) With sensor signal / relay energized / hold A at last value										K	CZ	4			
5) With sensor signal / relay de-energized / hold A at last value										K	CZ	5			
Lines 1, 2 and 3: Specify value of output signal span in %, any value from -10% to 110%; e.g. with output 4...20 mA corresponding 2.4 mA -10% and 21.6 mA 110%															
Lines 2 to 5: Cannot be combined with active trip point GW, Feature 12, lines 1 to 3 and Feature 13, lines 1 and 2															
11. Mains ripple suppression															
0) Frequency 50 Hz												. 0			
1) Frequency 60 Hz											Z	. 1			
12. Type and value of trip point GW and reset ratio, energizing delay and de-energizing delay of relay (for K)															
0) Alarm function inactive										L		. . 0			
1) Low alarm [%;%;s;s]										M	KZ	. . 1			
2) High alarm [%;%;s;s]										M	KZ	. . 2			
3) Rate-of-change alarm $\delta x / \delta t$ [%/s;%;s;s]										M	KZ	. . 3			
13. Sense of action of relay (for GW resp. K)															
0) Alarm function inactive											M	. . . 0			
1) Relay energized in alarm condition											KLZ	. . . 1			
2) Relay energized in safe condition											KLZ	. . . 2			

* Lines with letter(s) under "no-go" cannot be combined with preceding lines having the same letter under "SCODE".

Table 7: Explosion protection data

Order Code	Type of protection "Intrinsically safe" Marking		Type Examination Certificate	Mounting location of device
	Instrument	Measuring input		
604 - 23/24	[Ex ia] IIC	Ex ia IIC	ZELM 02 ATEX 0099 X	Outside the hazardous area

EURAX V 604

Programmable universal transmitter

Table 8: Temperature measuring ranges

Measuring range [°C]	Resistance thermometer		Thermocouple									
	Pt100	Ni100	B	E	J	K	L	N	R	S	T	U
0... 20												
0... 25	X	X										
0... 40	X	X		X	X		X					
0... 50	X	X		X	X	X	X				X	X
0... 60	X	X		X	X	X	X				X	X
0... 80	X	X		X	X	X	X				X	X
0... 100	X	X		X	X	X	X	X			X	X
0... 120	X	X		X	X	X	X	X			X	X
0... 150	X	X		X	X	X	X	X			X	X
0... 200	X	X		X	X	X	X	X			X	X
0... 250	X	X		X	X	X	X	X			X	X
0... 300	X			X	X	X	X	X	X	X	X	X
0... 400	X			X	X	X	X	X	X	X	X	X
0... 500	X			X	X	X	X	X	X	X		X
0... 600	X			X	X	X	X	X	X	X		X
0... 800			X									
0... 900			X	X	X	X	X	X	X	X		
0...1000			X	X	X	X		X	X	X		
0...1200			X		X	X		X	X	X		
0...1500			X						X	X		
0...1600			X						X	X		
50... 150	X	X		X	X	X	X	X			X	X
100... 300	X			X	X	X	X	X			X	X
300... 600	X			X	X	X	X	X	X	X		X
600... 900			X	X	X	X	X	X	X	X		
600...1000			X	X	X	X		X	X	X		
900...1200			X		X	X		X	X	X		
600...1600			X						X	X		
600...1800			X									
-20... 20	X	X		X	X		X					
-10... 40	X	X		X	X	X	X					X
-30... 60	X	X		X	X	X	X	X			X	X
Measuring range limits [°C]	-200 to 850	-60 to 250	0 to 1820	-270 to 1000	-210 to 1200	-270 to 1372	-200 to 900	-270 to 1300	-50 to 1769	-50 to 1769	-270 to 400	-200 to 600
	ΔR min 8 Ω at full-scale \leq 740 Ω ΔR min 40 Ω at full-scale $>$ 740 Ω to 5000 Ω		ΔU min 2 mV									

EURAX V 604

Programmable universal transmitter

Electrical connections

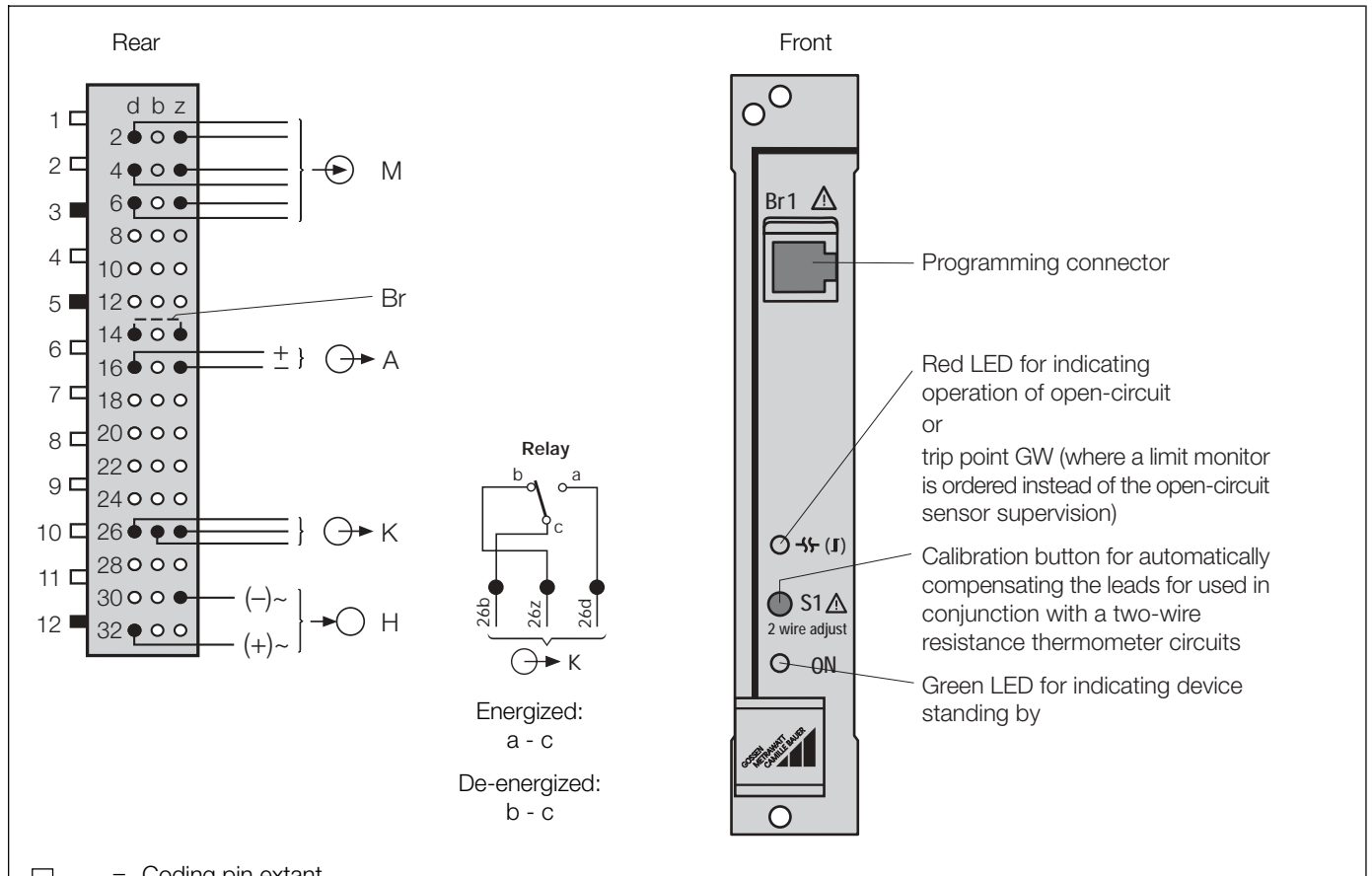

- = Coding pin extant
- = Coding pin broken out (For version Ex additional coding pin 1)
- = Contact fitted
- = Contact fitted (only for test purposes at the works)
- = No contact
- M = Measured variable / measuring input
The contact pin connections and the position of jumpers **A** and **B** depends on the kind of measurement and application (see "Table 9: Measuring input". Jumpers **A** and **B** are located on the PCB of EURAX V 604.
- A = Output variable / measuring output
- K = Output contact for open-circuit sensor or for monitoring limit GW, see Figure "Relay"
- H = Power supply
- Br = Jumper for safety circuit. A safety circuit may be looped via the jumper, for signalling "module unplugged" or "module not plugged in properly". This jumper **must no** be inserted on the Ex version.

Dimensional drawing

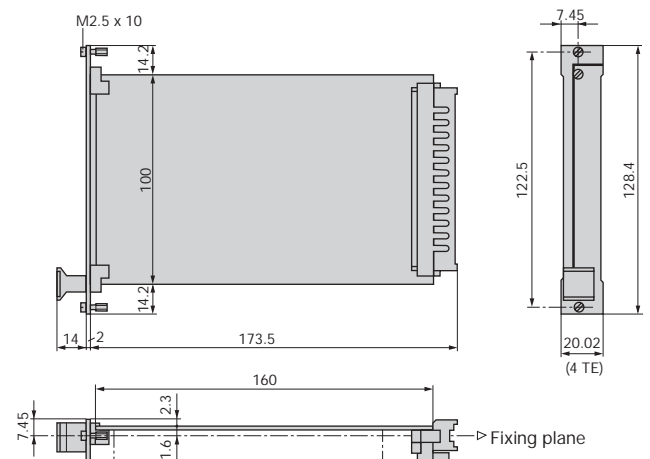

Fig. 5. EURAX V 604, front plate width 4 TE.

Standard accessories

- 1 Operating Instructions in three languages: German, French, English
- 1 Ex approval (only for "Intrinsically safe" explosion-proof [Ex ia] IIC devices)

EURAX V 604

Programmable universal transmitter

Table 9: Measuring input

Measurement	Measuring range	Measuring span	Position of jumpers	No	Wiring diagram Plug arrangement
DC voltage (direct input)	- 300...0...300 mV	2...300 mV		1	
DC voltage (input via potential divider)	- 40...0...40 V	0.3...40 V		2	
DC current	- 12...0... 12 mA / - 50...0...100 mA	0.08... 12 mA / 0.75...100 mA		3	
Resistance thermometer RT or resistance measurement R, two-wire connection	0... 740 Ω / 0...5000 Ω	8... 740 Ω / 40...5000 Ω		4	
Resistance thermometer RT or resistance measurement R, three-wire connection	0... 740 Ω / 0...5000 Ω	8... 740 Ω / 40...5000 Ω		5	
Resistance thermometer RT or resistance measurement R, four-wire connection	0... 740 Ω / 0...5000 Ω	8... 740 Ω / 40...5000 Ω		6	
2 identical three-wire resistance transmitters RT for deriving the difference	RT1 – RT2 0... 740 Ω / 0...5000 Ω	8... 740 Ω / 40...5000 Ω		7	
Thermocouple TC Cold junction compensation internal (Ni 100)	- 300...0...300 mV	2...300 mV		8	
Thermocouple TC Cold junction compensation external	- 300...0...300 mV	2...300 mV		9	
Thermocouple TC in a summation circuit for deriving the mean temperature	- 300...0...300 mV	2...300 mV		10	
Thermocouple TC in a differential circuit for deriving the mean temperature (Ni 100 not necessary)	TC1 – TC2 - 300...0...300 mV	2...300 mV		11	
Resistance sensor WF	0... 740 Ω / 0...5000 Ω	8... 740 Ω / 40...5000 Ω		12	
Resistance sensor WF DIN	0... 740 Ω / 0...5000 Ω	8... 740 Ω / 40...5000 Ω		13	

Printed in Switzerland • Subject to change without notice • Edition 07.03 • Data sheet No. V 604-2 Le

Camille Bauer LTD
Aargauerstrasse 7
CH-5610 Wohlen/Switzerland
Phone +41 56 618 21 11
Fax +41 56 618 24 58
e-mail: info@camillebauer.com
http://www.camillebauer.com

CAMILLE BAUER

Member of
GMC Instruments Group